

SERVICE-DOCUMENTATIE

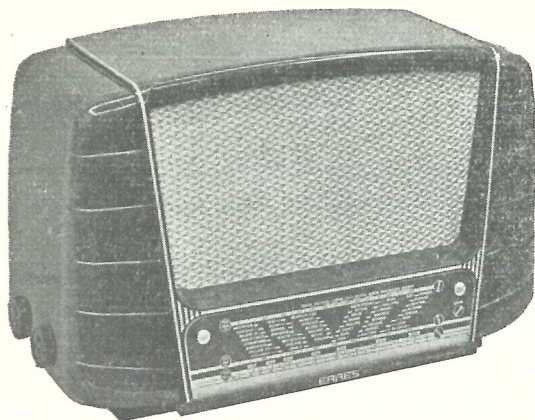

KY 534 U

ontvangtoestel voor wissel-
en gelijkstroom



ERRES RADIO

'n Van der Heem product

I. ALGEMENE GEGEVENS

1. Golfbereiken: Korte golf 13,5- 52 m
 Middengolf 175 - 585 m
 Lange golf 720 - 2000 m.
2. Buizen: UCH 42 - mengbuis oscillator
 UAF 42 - H.F. - versterker
 UBC 41 - detector - L.F. - versterker
 UL 41 - eindversterker
 Seleengelijkrichter: SSF E 220 C 80.
3. Kringen: Afgestemde H.F. - kringen: 1
 Afgestemde M.F. - kringen: 2 + 2
4. Middenfrequentie: Nominaal 450 Kc.
5. Gevoeligheid: Beter dan 10 μ V.
6. Uitgangsenergie: 2,5 W bij 10% vervorming gemeten bij een
 netspanning van 220 V en een signaal van
 400 Hz.
7. Selectiviteit: De M.F. bandbreedte voor 10 voudig signaal
 bedraagt 11 Kc.
8. Netspanningen: Omschakelbaar voor netspanningen van 125 V
 en 220 V.
 AC en DC.
9. Bedieningsorganen: Volumeregelaar + netschakelaar
 Toonregelaar + basschakelaar
 Afstemming
 Golfbereikschakelaar
10. Normale verpakking: 530 x 330 x 270 mm.
 Afmetingen kast : 400 x 265 x 160 mm.
11. Gewicht: Netto 6 kg, bruto 7,7 kg.

II. S C H E M A B E S C H R I J V I N G.

L.F. gedeelte:

De buizen B3 en B4 hebben niet ontkoppelde kathode weerstanden. Het versterkingsverlies van de L.F. trap wordt gecompenseerd door een meekoppelspanning, welke van de kathode van B4 naar de kathode van B3 gevoerd wordt.

Hoge tonen worden op de tap van de volumeregelaar opgehaald door middel van een spanningsdeling over de volumeregelaar. Via C26 worden de hoge tonen dan opgehaald.

Door R5 met een meekoppelspanning te verbinden, wordt de hoog-weergave nog geaccentueerd.

Verbetering van de lage tonen weergave geschiedt door de combinatie R6-C27.

Toonregeling geschiedt met behulp van R17 en C33. Minimum hoog is aanwezig als de kathode van B3 voor het hoog tegengekoppeld wordt. C33 is dan verbonden met S26.

Spanningen en stromen gemeten bij een netspanning van 220 volt:

		B 1 UCH 42		B 2 UAF 42	B 3 UBC 41	B 4 UL 41
		hexode	triode	penthode	triode	penthode
Va	V	165	110	165	89	200
Vg (2+4)	V	60	-	64	-	165
Vk	V	0	0	0	1,1	9,1
Ia	mA	1,7	4,5	4,7	0,33	40
Ig (2+4)	mA	2,4	-	1,55	-	6,6

$$V_{C35} = 200 \text{ V} \quad V_{C36} = 165 \text{ V} \quad I_{\text{tot}} = 62 \text{ mA} \quad I_{\text{net}} = 215 \text{ mA bij 220 V.}$$

Spanningen en stromen gemeten zonder antennesignaal. Voltmeter 10000 ohm/V.

III. T R I M V O O R S C H R I F T.

Wijzerinstelling: De wijzer moet bij minimumstand van de afstemcondensator op het begin van de schaal worden ingesteld (merkteken).

Afregeling: De volumeregelaar op maximum en de toonregelaar op hoog instellen. Afregelen als aangegeven in hierna volgende tabel:

Bereik	Meet frequentie	Condensatorstand	Aansluiting	Afregelen	
M.F.	450 Kc	180°	Via cond. 22000 pF op gl UCH 42	S15/S16, S19/S20, S21/S22, S19/S20, S17/S18, S15/S16.	
M.F. ant. filter	450 Kc	M.G. 180°	via kunst- antenne	C2 op minimum output	
K.G. I	6,1 Mc 21 Mc	165° 15°	via kunst- antenne	osc.kring	ant.kring
				S10 C14	S3 C4
M.G.	550 Kc 1600 Kc	160° 15°	idem	S12 C15	S5 C5
	L.G.	160 Kc 400 Kc		150° 15°	idem

IV. REPARATIE EN UITWISSELING VAN ONDERDELEN.

A. Uit de kast nemen van het chassis:

1. Achterschot en service-luik verwijderen.
2. Verlichting en luidspreker lossolderen.
3. Wijzer van snaar losnemen.
4. Knoppen verwijderen (schroef aan binnenzijde kast losdraaien, knop aftrekken).
5. Bodemschroeven losdraaien na verwijdering van de twee houten klosjes.
6. Chassis uit de kast schuiven.

B. Aandrijfsnaren:

Lengte van de aandrijfsnaren zoals in fig. 4 is aangegeven.

CONDENSATOREN

C 1	1000 pF	E 203 20/1K	C20	100 pF	E 300 02/100E
C 2	3-30 pF	7864/01	C21	100 pF	E 300 02/100E
C 3	4700 pF	E 203 20/4K7	C22	22000 pF	E 200 10/22K
C 4	3-30 pF	7864/01	C23	100 pF	E 103 10/100E
C 5	6-30 pF	49 005 49	C24	100 pF	E 300 02/100E
C 6	6-30 pF	49 005 49	C25	100 pF	E 300 02/100E
C 7	10 pF	E 101 10/10E	C26	4700 pF	E 201 10/4K7
C 8	220 pF	E 103 10/220E	C27	22000 pF	E 200 10/22K
C 9	9-500 pF)	5127 A/00	C28	4700 pF	E 201 10/4K7
C10	9-500 pF)		C29	1000 pF	E 201 20/1K
C11	470 pF	E 103 10/470E	C30	220 pF	E 103 10/220E
C12	47 pF	E 102 10/47E	C31	4700 pF	E 201 10/4K7
C13	120 pF	E 103 05/120E	C32	10000 pF	E 203 20/10K
C14	6-30 pF	49 005 49	C33	22000 pF	E 200 10/22K
C15	6-30 pF	49 005 49	C34	22000 pF	E 204 20/22K
C16	495 pF	E 302 01/495E	C35	50 μF)	5314K/50+50
C17	47 pF	E 102 10/47E	C36	50 μF)	
C18	6-30 pF	49 005 49	C37	0,1 μF	E 201 10/100K
C19	135 pF	E 301 01/135E	C38	0,1 μF	E 201 10/100K

WEERSTANDEN

R 1	1 MΩ	GK 776 10/1M	R14	39000 Ω	GK 776 10/39K
R 2	22000 Ω	GK 776 10/22K	R15	0,1 MΩ	GK 776 10/100K
R 3	2,2 MΩ	GK 776 10/2M2	R16	180 Ω	GK 776 10/180E
R 4	0,27 MΩ	GK 776 10/270K	R17	50000 Ω	GK 809 01
R 5	15000 Ω	GK 776 10/15K	R18	220 Ω	100 026/01
R 6	15000 Ω	GK 776 10/15K	R19	2x500 Ω	GK 790 07 2 x
R 7	47000 Ω	GK 776 10/47K	R20	180 Ω	GK 790 08
R 8	0,05+0,45 MΩ	GK 809 02	R21	10000 Ω	GK 777 10/10K
R 9	1 MΩ	GK 776 10/1M	R22	1200 Ω	GK 778 10/1K2
R10	1800 Ω	GK 776 10/1K8	R23	18000 Ω	GK 777 10/18K
R11	1000 Ω	GK 776 10/1K	R24	27000 Ω	GK 777 10/27K
R12	0,68 MΩ	GK 776 10/680K	R25	0,1 MΩ	GK 776 10/100K
R13	10 MΩ	GK 776 10/10M			

SPOELEN ENZ.

S 1	400 W	35 Ω	zuigkringspoel	S15)	95 W	1,8Ω	
S 2)	15½ W	1,8 Ω	GK 565 94	S16)	225 W	5,7Ω	MF I
S 3)	10½ W		ant. spoel 13-52 m	S17)	95 W	2,6Ω	trafo
			GK 565 95	S18)	225 W	4,9Ω	GK 566 01
S 4)	600 W	95 Ω	ant. spoel 180-585m	S19)	95 W	1,8Ω	
S 5)	128 W	5 Ω	GK 565 96	S20)	225 W	5,7Ω	MF II
S 6)	1150 W	185 Ω	ant. spoel 720-2100m	S21)	95 W	4,5Ω	trafo
S 7)	480 W	38 Ω	GK 565 97	S22)	225 W	3,2Ω	GK 566 02
S 8)	26 W	1,7 Ω		S23)	1600 W	136Ω	
S 9)	4 W	1 Ω	osc.spoel 13-52m	S24)	90 W	8,2Ω	
S10)	10 W	1 Ω	GK 565 67	S25)	73 W	0,32Ω	uitgangs-
				S26)	56 W	43,5Ω	trafo
S11)	27 W	1,8 Ω	osc. spoel 180-585m	S27)	19 W	15,6Ω	GK 893 14
S12)	87 W	5,5 Ω	GK 566 66	S28)	17 W	14,1Ω	
S13)	56 W	5 Ω	osc. spoel 720-2100m				
S14)	215 W	15 Ω	GK 566 67				

FIG. 1

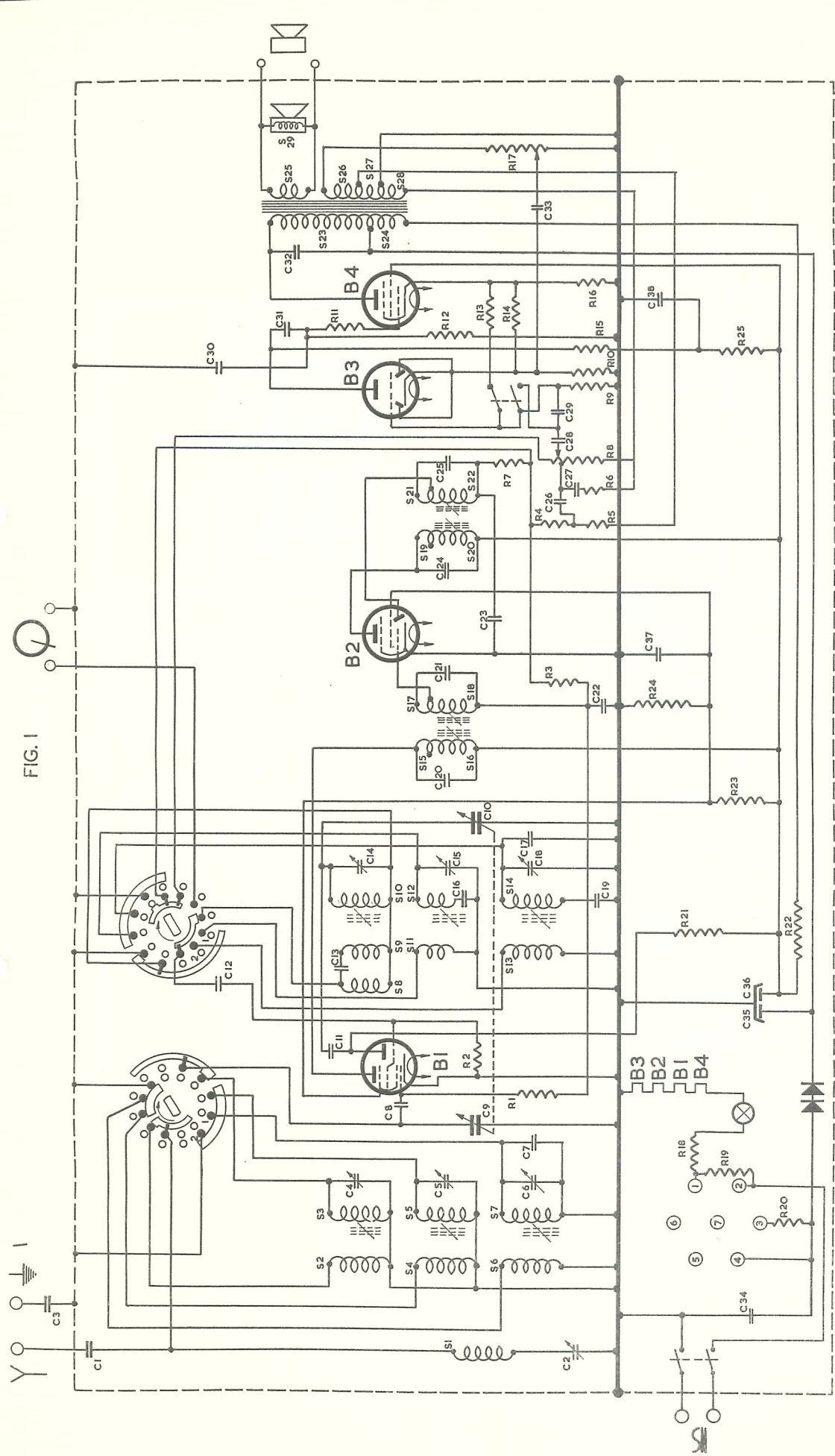

GOLFBREIKSCHAKELAAR 4 STANDEEN: KG, MG, LG, GRAM.
 GETEKEND IN STAND: KG
 110-127V = 6-7,1-2-4
 220V = 1-7,2-3-5

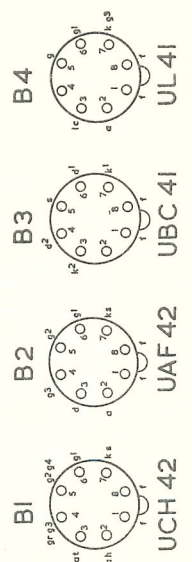

S	1,	2,4,6,	3,5,7,	8,	9,11,13,	10,12,14,	15,16	17,18	19,20,	21,22,	23,24,	25,26,27,28,29,	30,	31,	32,	33,	34,	35,	36,	37,	38,	39,	40,	41,	42,	43,	44,	45,	46,	47,	48,	49,	50,	51,	52,	53,	54,	55,	56,	57,	58,	59,	60,	61,	62,	63,	64,	65,	66,	67,	68,	69,	70,	71,	72,	73,	74,	75,	76,	77,	78,	79,	80,	81,	82,	83,	84,	85,	86,	87,	88,	89,	90,	91,	92,	93,	94,	95,	96,	97,	98,	99,	100,													
C	1,2,	3,4,3,	4,5,6,	7,	8,	9,	10,	11,	12,	13,	14,	15,16,17,	18,	19,	20,	21,	22,	23,	24,	25,	26,27,	28,	29,	30,	31,	32,	33,	34,	35,	36,	37,	38,	39,	40,	41,	42,	43,	44,	45,	46,	47,	48,	49,	50,	51,	52,	53,	54,	55,	56,	57,	58,	59,	60,	61,	62,	63,	64,	65,	66,	67,	68,	69,	70,	71,	72,	73,	74,	75,	76,	77,	78,	79,	80,	81,	82,	83,	84,	85,	86,	87,	88,	89,	90,	91,	92,	93,	94,	95,	96,	97,	98,	99,	100,		
R	1,	2,	3,	4,	5,	6,	7,8,	9,	10,	11,12,13,14,	15,	16,	17,	18,	19,	20,	21,	22,	23,	24,	25,	26,	27,	28,	29,	30,	31,	32,	33,	34,	35,	36,	37,	38,	39,	40,	41,	42,	43,	44,	45,	46,	47,	48,	49,	50,	51,	52,	53,	54,	55,	56,	57,	58,	59,	60,	61,	62,	63,	64,	65,	66,	67,	68,	69,	70,	71,	72,	73,	74,	75,	76,	77,	78,	79,	80,	81,	82,	83,	84,	85,	86,	87,	88,	89,	90,	91,	92,	93,	94,	95,	96,	97,	98,	99,	100,

FIG. 2

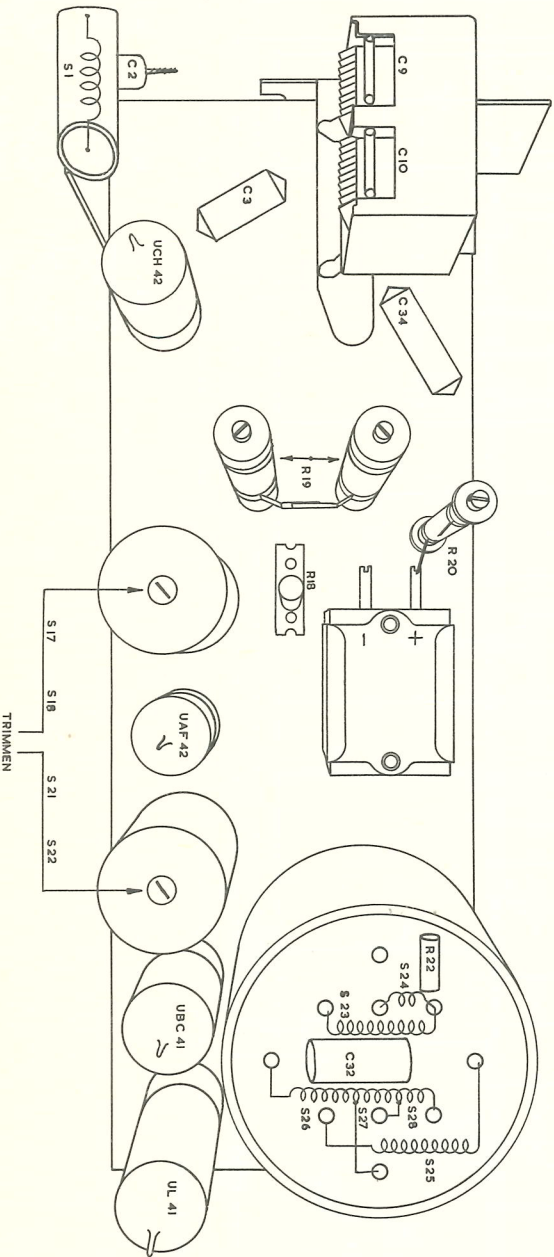
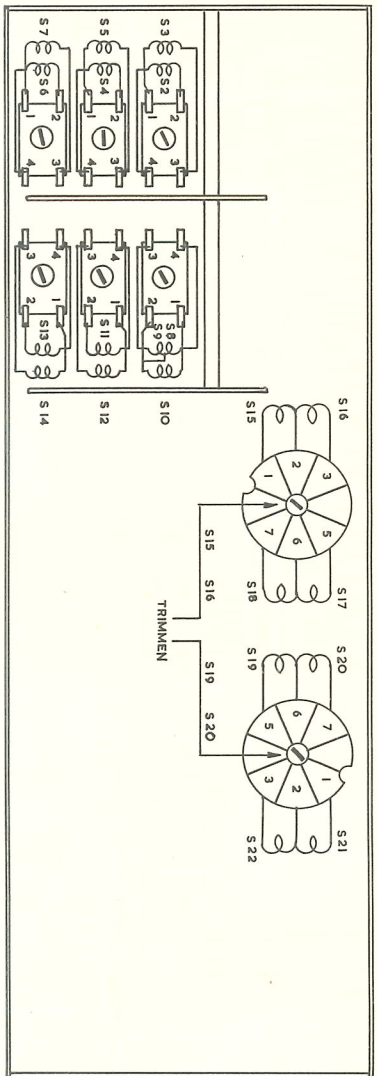

C	9,2,	10, 3,	34,	19,	20, 18,	17, 18,	20, 19,	22,	32,	C
R										R
S	1,	3,5,7, 2,4,6,		8,9,11,13,10,12, 14, 16,15,				21,22, 24, 23,	28,27,26, 25,	S

FIG. 3

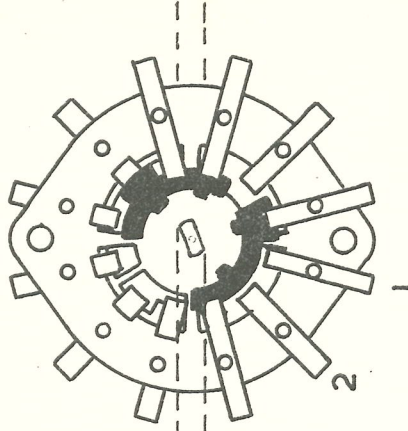
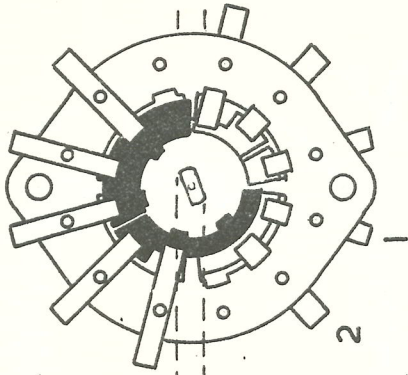
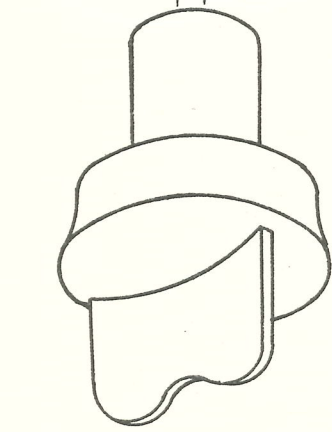

GK 882 47

GK 882 48

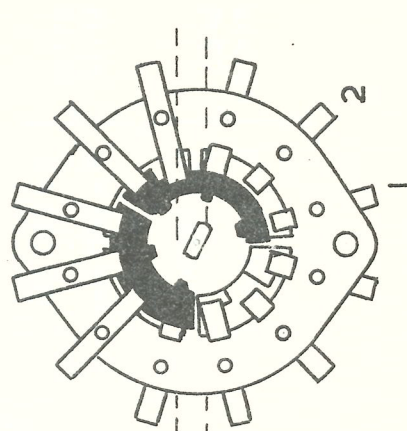
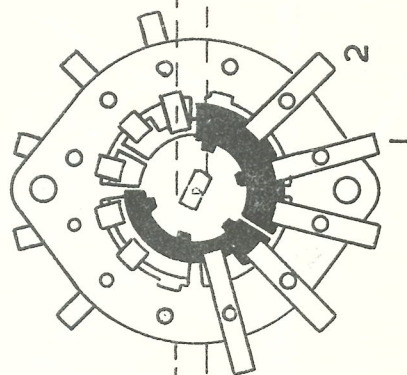
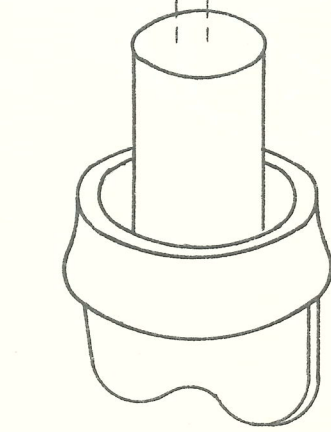
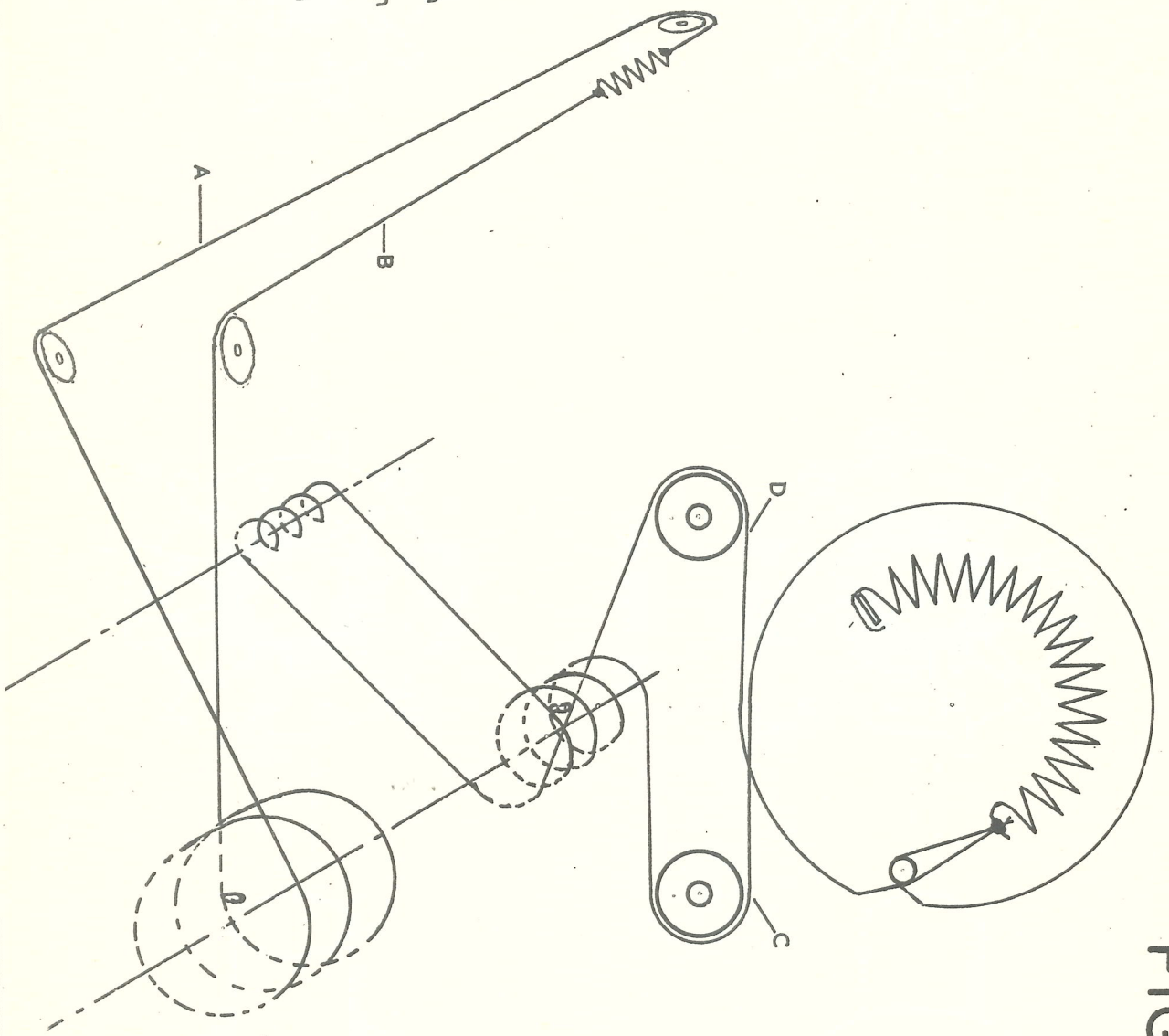

FIG. 4



STAAL
LITZE
A = 650 mm
B = 300 mm

SPEC
Koord
C = 295 mm
D = 385 mm

KY 534

FIG. 5

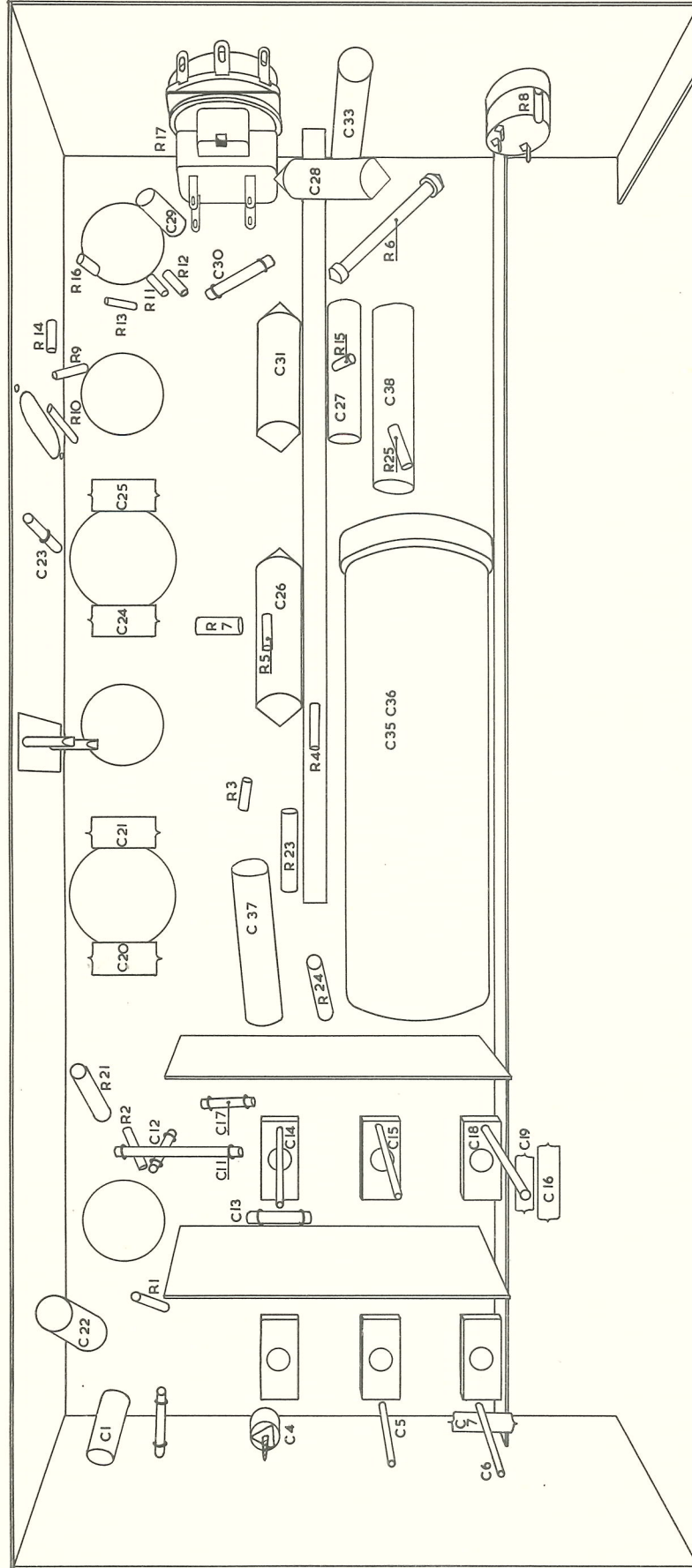

C	1	4	5	6	7	8	22	11 1/2	19	2	21	24	20	37	21	23	3	4	35	36	23	24	25	26	27	31	38	30	29	28	33	C
R																																R
S																																S

FIG. 1A

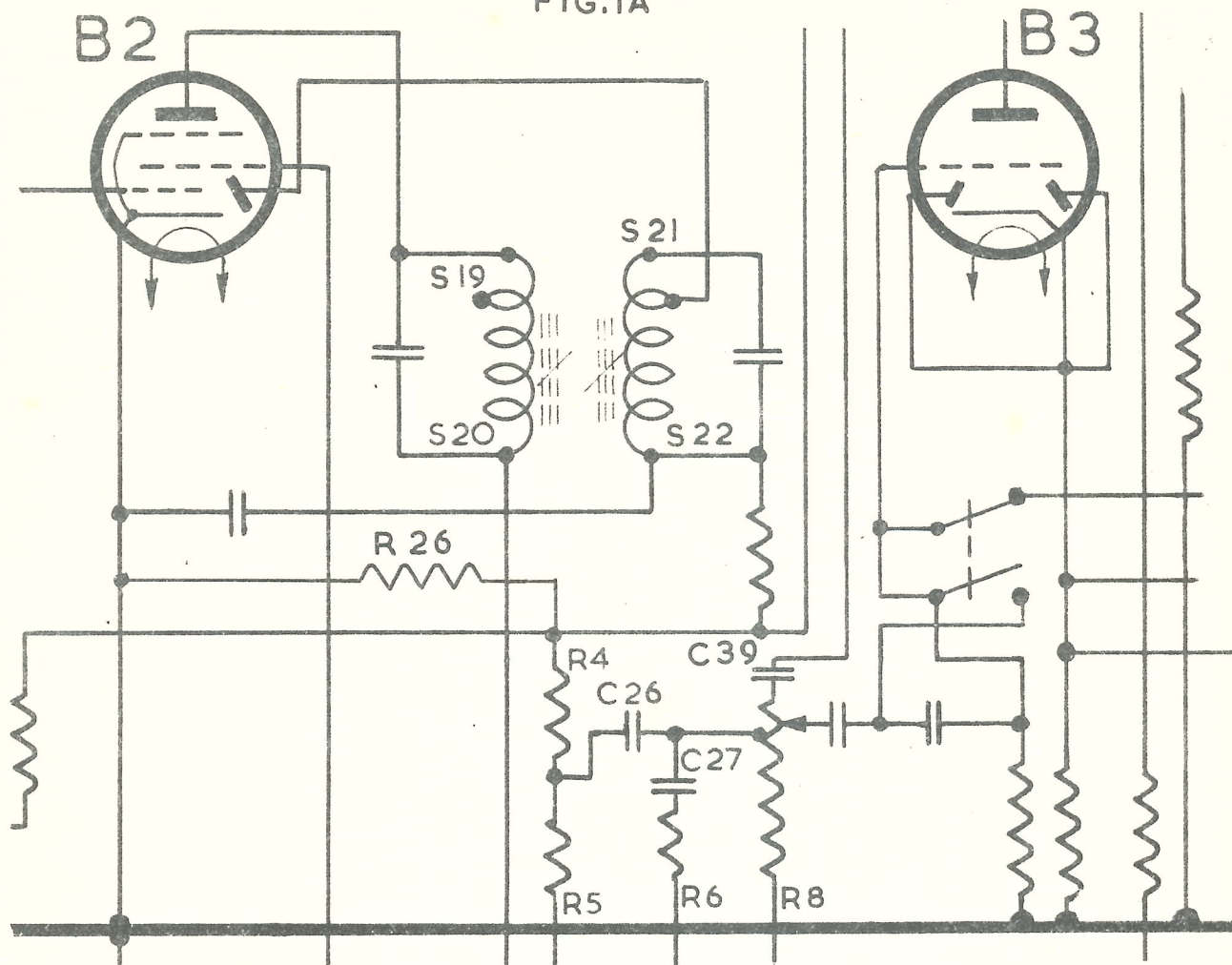

A A N V U L L I N G

Voor die toestellen, waarvan de volumeregelaar stroomloos geschakeld is, zie fig. 1 A.

R 26 = M 18	Ω GK 776 10/180K
R 4 = 1 M	Ω GK 776 10/1M
R 5 = 47000	Ω GK 776 10/47K
R 6 = 47000	Ω GK 776 10/47K
R 8 = 8,2 + 1,8 M	Ω GK 809 17
C 26 = 1000	pF E 201 10/1K
C 27 = 4700	pF E 201 10/4K7
C 39 = 10000	pF E 200 10/10K